

**HOBART**

**WAREWASHING**  
RACK-TYPE DISHWASHER **CP** | **CN**



# 132 DIFFERENT PARTS





**HOBART**

**TOTAL PERFORMANCE  
IN YOUR KITCHEN**

At HOBART, we take pride in providing reliable, high quality kitchen equipment that has been engineered and tested to ensure that whatever challenges the days bring - you can make it happen with HOBART!

**Let's make it happen!**



**HOBART**

**7 BRANCHES / MARKETS**

many challenges

**1 SOLUTION**



**HOSPITALITY**

Bar & Pub / Bistro & Café /  
Hotel & Restaurant



**FOODSERVICE**

Hospital / Nursing Home / Canteen /  
Education - School & University



**BAKERY**

Bakery subsidiary / Production / Bakery industry



**MEAT MARKET**

Butchery / Meat production industry



**INDUSTRY**



**GLOBAL MARINE**



**AIRLINE CATERING**





## BETTER OR BEST IT'S YOUR CHOICE!

The **PROFI** line - everything a professional operator needs. The successful product series from HOBART can be found working wherever the highest standards of cleanliness are required, tailored to the volumes to be washed and the degree of soiling of the ware. It combines efficient warewashing with ultimate user-friendliness and low operating costs. Numerous equipment options make **PROFI** line a perfectly suited warewashing solution to suit any operation.

### PROFI LINE

The **PREMAX** line are the perfect models for operators that need a higher level of proficiency. Because **PREMAX** sets standards in all areas. Minimal operating costs and impressive user-friendliness, combined with maximum performance. The **PREMAX** line is the most economical and innovative line of dishwashers on the market. In addition to the features of **PROFI** models, **PREMAX** wins over users with its unique product characteristics and is the ideal partner for the highest standards in a perfect warewashing operation.

### PREMAX LINE

## THE MODELS

WE HELP YOU WITH YOUR DECISION!

### PROFI CN

Professional, powerful and reliable for the daily challenges in the commercial scullery.



---

## PREMAX LINE EXCLUSIVE

### PREMAX CP

The machine of choice when you are looking for optimum economic efficiency. With its unique features, it greatly improves the processes in your scullery and is fit for any challenge.



**HOBART**

**HOBART**



**HOBART**

# HIGH LEVEL OF ECONOMY

## PREMAX LINE LINE EXCLUSIVE

### 50PERCENT FRESH WATER RINSE

Optimum rinsing of cleaning chemicals

#### Save up to 60 % of water - the 50PERCENT fresh water rinse permits you to do so:

The fresh water rinse is used to rinse off the cleaning chemicals. Distribution of the water is the crucial factor with regard to the required volume of water.

The patented 50PERCENT fresh water rinse is equipped with special precision nozzles. These disperse the rinse water into a fine curtain of water and thus form a water film on the wash ware. As a result of the ideal water distribution, this micro-thin film is sufficient to rinse off the wash water. In addition to the conventional rinsing, the 50PERCENT fresh water rinse sprays the wash ware also with lateral spray arms.

#### YOUR BENEFITS AT A GLANCE

- Reduction of the fresh water volume by up to 60 %.
- Rinses the wash water off the wash ware in an optimum manner.
- Significant reduction of rinse aid and energy demand.

## PREMAX LINE LINE EXCLUSIVE

### TOP-TEMP ENERGY MANAGEMENT

Prevents energy losses before they arise

#### Reduce the energy loss of your dishwashing system by up to 20 % with the patented and standard energy management.

In this system, the hot machine zones are enclosed by the cooler zones such as pre-wash and drying. The resulting temperature curtain ensures that air exchange can only take place within the machine. The rack-type dishwashers of the **PREMAX** line are characterised by a special temperature profile and exploits this principle in an optimal manner.



# HIGH LEVEL OF ECONOMY

## CLIMATE ENERGY SAVING SYSTEM

For an efficient use of energy

### Lower your costs - Increase your efficiency - Protect the environment:

the CLIMATE energy saving system not only helps you to prevent energy losses, but also to lower the operating costs of your rack-type dishwasher.

### HOW DOES THAT WORK?

The energy of the hot exhaust air is continuously returned to the machine by means of a heat recovery system. Savings up to 10 kW/h are possible in this manner.

### YOUR BENEFITS:

- Your machine's operating costs are significantly reduced..
- The energy provided is used in an efficient manner.
- Losses through the exhaust air are reduced to a minimum.

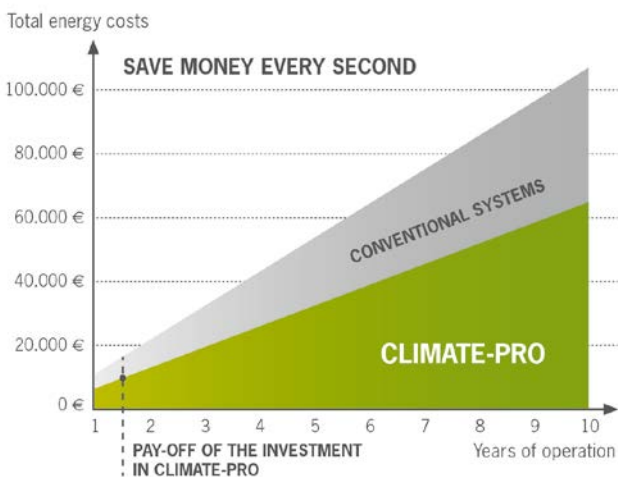

## CLIMATE-PRO ENERGY SAVING SYSTEM

### Innovation meets economy meets energy efficiency:

You can save up to 22 kW/h with the novel energy system CLIMATE-PRO.

### OUR INTELLIGENT SOLUTION FOR YOU:

The thermal energy contained in the exhaust air is 100 % regenerated by means of state-of-the-art technology and returned to the rinse process. This not only helps you to reduce the energy consumption of your machine but also to save on the related operating costs.

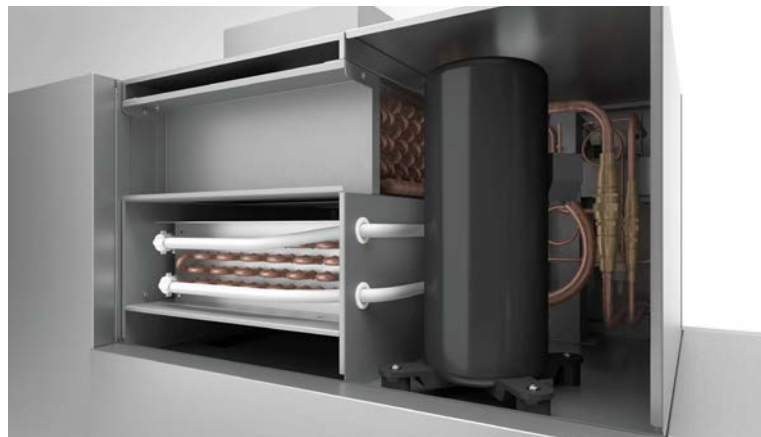

### BY THE WAY:

As a result of constantly low exhaust air temperatures of 17°C, the room climate is improved in compliance with VDI 2052.

## EFFICIENCY CONCEPT

Clever technology paired with efficient use

### Saving on operating costs made easy:

The innovative efficiency concept lowers your costs, avoids energy losses and reduces the exhaust air volume. Eliminates the need for direct connection to an on-site exhaust hood.

## CLEANING MANAGEMENT

A good cleaning result depends on many parameters. The innovative cleaning management optimally combines mechanics, circulation output, water distribution, chemical agents, time, and contact area. As a consequence, this innovative cleaning management achieves top cleaning results while providing for

- additional energy savings,
- lower connected loads,
- reduced heat losses.

## EXHAUST AIR MANAGEMENT

As the new cleaning management reduces water circulation, this has an immediate effect on the formation of waste steam.

### BECAUSE:

Less waste steam means less exhaust air. The reduced exhaust air volume eliminates the need for direct connection to an on-site ventilation system.

## LOW-CHEM

## DETERGENT SAVING SYSTEM

### Reduce your detergent consumption and go easy on your purse!

The total fresh water amount is divided and the patented LOW-CHEM detergent saving system of the **PREMAX** line directs only 75 l, that of the **PROFI** line 105 l of fresh water into the wash tank for regeneration of the wash water.

Only this amount is directed into the main wash and mixed with detergent. Detergent dosing depends on the fresh water volume, which means you save on a corresponding amount of chemicals. The remaining water is directly pumped into the pre-wash tank via a bypass line.

### YOUR RESULT:

Compared to conventional systems, the **PREMAX** line reduces your detergent consumption by up to 80 % and the **PROFI** line by up to 70 %.

## COOL POWER PACKAGE

with payback

- reduction of energy consumption
- reduction of CO<sub>2</sub> emission
- reduction of exhaust temperature
- reduction of operation costs



# BEST WASH RESULT

PREMAX LINE LINE EXCLUSIVE

## HOT-TEMP WASHING

Improves the effect of chemicals

**Did you know that the water temperature has the biggest influence on the wash result?**

Compared to conventional dishwashing systems, the HOT-TEMP washing cleans the wash ware at approx. 67 °C - instead of 60 °C. This leads to a significant increase in the efficiency of the chemicals and the wash ware gets clean faster.

### BY THE WAY:

HOT-TEMP washing increases the capacity of the rack-type dishwasher by up to 50 %. In turn, this means the machine also takes up less space.



## TRI-RINSE

Minimises the detergent concentration

The patented three-stage TRI-RINSE system consists of the pre-rinse nozzle, the pumped rinse, and the fresh water final rinse.

The new pre-rinse nozzle is located upstream of the pumped rinse and rinses off the wash water from the wash ware. The wash water is guided back into the wash tank by the deflector. This ensures that almost no detergent will get into the downstream pump rinsing.

**FOR YOU THIS MEANS** that there is less detergent in the water of the rinse, which significantly improves the wash result.



### CONTACT-PLUS WASH SYSTEM

**Innovative wash arms allow the wash water to come into prolonged contact with the wash ware and provide for an improved wash result:**

During the washing operation, an even distribution of the wash water is essential to achieve a perfect cleaning result. For the wash jets to be most effective, they were given a special shape by HOBART so that compared to conventional systems, they cover a larger area in a more accurate manner.

**YOUR BENEFIT:**

The even and compact distribution of the wash water on the wash ware provides for a significantly improved wash result.

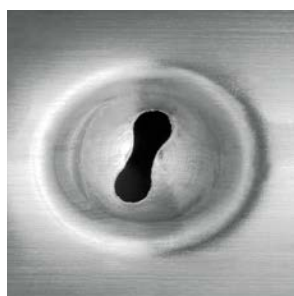

### RO-L REVERSE OSMOSIS SYSTEM

Eliminates water stains before they arise

Unsightly stains on glasses, plates or knife blades? Minerals in water often leave visible residues when dishes are dried, thus creating an unattractive impression.

**PUT AN END TO TEDIOUS MANUAL POLISHING**

Reliable, stain-free, and hygienic: Continuous treatment with state-of-the-art membrane and filter technology ensures fully demineralised water. This permanently provides for hygienically clean wash ware without any stains. Hygienic risks as a result of manual polishing are already prevented in advance.

**BY THE WAY:**

The RO-L reverse osmosis system can be comfortably set up in a separate casing next to the dishwasher. If a small footprint is of importance, it can also be integrated in the rack-type dishwasher.





# BEST DRYING RESULT

## DYNAMIC-DRY DRYING

Makes drying the dishes easy!

Do you usually take a dish towel to re-dry cups, dishes or containers? Put a stop to this extra work - and to dishes that leave the machine still wet.

Our DYNAMIC-DRY drying employs sophisticated state-of-the-art fan technology. It provides for higher air speeds and thus increased efficiency. You'll see the result immediately in your wash ware: even deep indentations, recesses or hollow bodies will be completely dry. At the same time, the DYNAMIC-DRY fan is particularly energy-efficient and consumes less energy than conventional systems.

### YOUR BENEFIT:

You get an optimum drying result and save the time for manual re-drying.

## PREMAX LINE LINE EXCLUSIVE

### HIGH-TEMP PUMPED RINSE

Increases the self-drying effect

#### Improved drying result paired with a reduced use of energy:

Temperature is a key component for a perfect drying result. This is why the patented pumped rinse of the **PREMAX** line circulates the additionally heated water several times, thus heating the wash ware even more and consequently increasing the self-drying effect.

#### YOUR BENEFITS:

The drying result is considerably optimised while energy is saved in the drying zone.

# PERMANENT-CLEAN

## PERMANENT-CLEAN AUTOMATIC SOIL REMOVAL

Prevents dirt spread in the machine



In the normal daily routine it is difficult to avoid food waste entering the pre-wash zone of the rack-type dishwasher. This may heavily contaminate the wash water so that the water has to be changed several times.

### WE HAVE THE SOLUTION:

The PERMANENT-CLEAN automatic soil removal will prevent this from happening by pumping coarse soil from the pre-wash zone into a strainer drawer by means of a sophisticated filter system. Food residues can then be conveniently removed from the drawer at the end of the dishwashing shift. This eliminates the time-consuming chore of emptying the filter basket, interrupting operation. This not only reduces the consumption of water, power and chemicals, but also keeps operating costs low. In addition, this protects your dishwashing system and is gentle on the environment.

### YOUR BENEFITS AT A GLANCE

A long day of dishwashing without changing the water, but instead with a hygienically pure wash result - even in the presence of extreme soiling.

- A clean pre-wash result is guaranteed at all times.
- A consistently high wash water quality is maintained.
- Wash tanks need to be emptied and filled with fresh water less often.

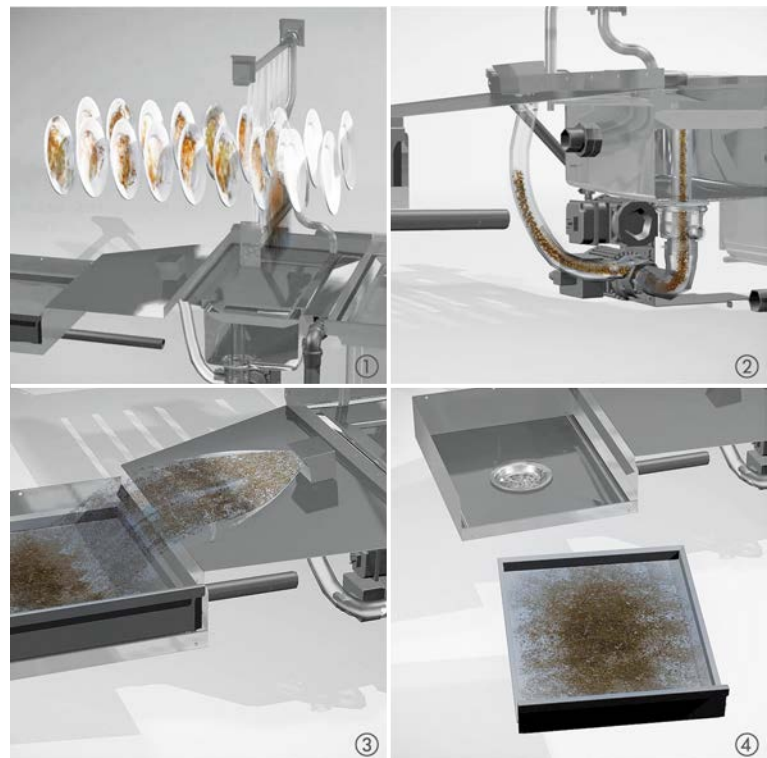

**Phase ①:** Coarse soiling is removed from the wash ware early, in the pre-wash zone.

**Phase ②:** The coarse soiling washed off is automatically and cyclically removed from the pre-wash zone.

**Phase ③:** The process water available washes the coarse soiling into the filter drawer in the appliance intake.

**Phase ④:** Convenient removal of the accumulated soiling residues at the end of the dishwashing shift.

# SENSOTRONIC WASHING INTELLIGENCE

## AQUA-ADAPT WATER CONSUMPTION CONTROL

Intelligent and efficient management of your water consumption!

The AQUA-ADAPT water consumption control automatically adapts the fresh water consumption per hour to the selected transport speed. The water quantity per machine meter is always ideal. In warewashing systems fitted with a tray-return conveyor belt the speed and fresh-water consumption are adjusted automatically.

### YOUR BENEFIT:

This for instance avoids unnecessarily high water consumption at low machine speeds. The wash ware is always cleaned with the same amount of water irrespective of the machine speed, thus achieving an even wash result.

**PREMAX** LINE LINE EXCLUSIVE

## SENSO-ACTIVE RESOURCE MANAGEMENT

Fresh-water consumption constantly at the ideal minimum

The SENSO-ACTIVE resource management system takes it a step further in innovative washing, keeping the fresh-water consumption down to a necessary minimum. The smart soiling sensor detects any increased soiling in the appliance and automatically increases the amount of fresh water supplied to the system.

### YOUR BENEFIT:

This ensures fully automatically a high tank water quality while keeping the average water consumption extremely low.

## SENSO-SPACE COMPARTMENT DETECTION

### Five benefits all at once:

Save water, go easy on your purse, be gentle on the environment and reduce your energy and chemical consumption!

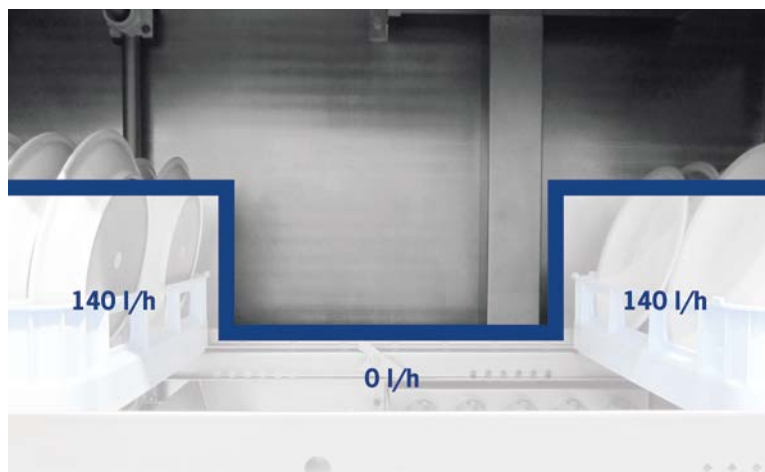

### HOW DOES THIS WORK?

As a result of irregular washing volumes during a wash cycle, your rack-type dishwasher will not be fully utilised. There will be empty compartments between the wash ware. The patented SENSO-SPACE compartment detection automatically detects these gaps and immediately regulates fresh water consumption down to a necessary minimum.

## PREMAX LINE LINE EXCLUSIVE

### BEST-START SYSTEM CHECK

Automatic monitoring of functions

Always keep up to date: Each time the rack-type dishwasher is filled with fresh water, the functions of heating systems, wash systems, drain valves and strainer systems are automatically checked.

### CLEARLY STRUCTURED, COMPREHENSIBLE DISPLAY

The status of machine components of the **PREMAX** line is indicated in an easily comprehensible manner by means of the colour touch screen control. Deviations from the nominal status are indicated by means of symbols and text. Our intelligent system automatically suggests corrective measures.

## PREMAX LINE LINE EXCLUSIVE

### WASH WARE DETECTION

The intelligent way to wash glasses and cutlery

The requirements when washing glasses and cutlery are particularly high and are different to those for dishes, pots or trays. With the HOBART wash ware detection you will in future be assisted by an intelligent helper that automatically adapts to the high standards for glass and cutlery cleaning.

### HOW DOES THAT WORK?

The encoded racks are detected by the sensors in the rack-type dishwasher. This causes the relevant dishwashing parameters to be automatically adapted - leaving you with a perfect wash result.





# RACK-FLOW SENSOR SYSTEM

## RACK-FLOW SENSOR SYSTEM

Increase the efficiency in your kitchen!

### One-man operation made easy:

Operating a warewashing system with one person only used to take plenty of time. In the case of a short unloading table, the operator has to walk from the intake to the end of the machine to unload the clean wash ware every few racks. This means constant moving between entry and exit of the machine and necessary hand washing due to hygiene safety rooms.

### AND WHY IS THAT SO?

With conventional washing processes, the foremost rack actuates the mechanical limit switch at the end of the unloading table after a short time, which interrupts the washing process until the rack has been emptied. The other racks remain in the dishwasher and are washed only once the rack is empty.

### HOBART HAS A FASTER AND BETTER SOLUTION

The RACK-FLOW sensor system (patent pending) helps you to get the most out of your dishwasher. Intelligent control technology allows for loading the machine over its entire length and using it without long interruptions. Thus, you can wash double the number of racks than before.

### HOW DOES THAT WORK?

Our intelligent RACK-FLOW sensor system prevents the first rack from moving all the way to the limit switch but stops it instead at the end of drying. During this time, the operator can continue loading racks into the dishwasher, thus using the entire machine length.

### FOR YOU, THIS MEANS:

With the RACK-FLOW sensor system, you save valuable time, optimise the processes in the scullery, and improve your efficiency.



# EASY HANDLING



## INFOTRONIC CONTROL

Added comfort and perfect overview at one glance

### Compact and operator-friendly:

The display of the INFOTRONIC control offers a clearly structured user interface. All key information on operating modes, status and temperatures are shown clearly and concisely.

### ADDITIONAL FUNCTIONS WITH INTUITIVE ACCESS VIA THE CUSTOMER MENU

#### For example:

- the documentation of the maintenance history compliant to DIN,
- the indication of the water and power consumption,
- the flexible programming of the autostart programme
- and the optional data download via the USB port.

## PROTRONIC XL CONTROL

The self-explanatory operating concept

**Innovative operating convenience at the highest level:** We have developed the PROTRONIC XL control to make operating your rack-type dishwasher as fast and as easy as possible. In future, not only operation will be made a lot easier, but also documentation and controlling.

The self-explanatory user interface assists the operator in quickly finding his way around the clearly laid out touch screen. All key hygiene-related information and functions become visible at a glance. Depending on their authorisation level, different user groups can see different information.

### Some additional innovative functions turn the PROTRONIC XL into a unique product:

- Exact-zone visualisation of temperature and fault messages.
- Automatic keeping of the maintenance history according to DIN.
- Convenient data storage in the control.
- A message management system is included.
- Visualisation of the operating manual.





# EASY HANDLING

## DROP-IN WASH SYSTEM

Facilitates cleaning

**Make cleaning the machine as easy as possible for yourself:** Thanks to the easy removal and reliable insertion of the wash systems by means of a drawer slide, cleaning work is turned into child's play.



## WASH ARM SLIDER

### Quickly ready for cleaning:

Our patented wash arm sliders allow you to clean the interior of the wash arms easily and comfortably. While conventional systems required you to unscrew the end caps of the wash arms first, now a single step is sufficient to get to the wash arm opening.

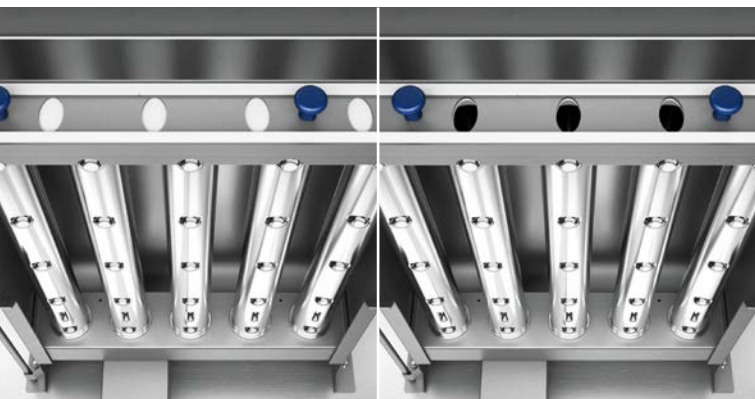

## COMPREHENSIVE CLEANING ASSISTANCE

Guaranteed orientation for cleaning

### Colour-coded cleaning assistance:

Machine cleaning made easy: daily cleaning of your rack-type dishwasher increases the performance and service life of your dishwashing system. To assist you in recognising which elements need to be removed for cleaning, these are provided with a blue marking.

### Colour-coded curtains:

The curtains separating the different wash zones are clearly marked, preventing them from being mixed up when they are re-inserted.

### Colour-coded wash and rinse arms:

The clear identification of the wash and rinse arms prevents them from being mixed up when they are inserted.

## AUTO-CLEAN SELF-CLEANING SYSTEM

**Cleaning your rack-type dishwasher has never been so easy:** Hygiene is the key factor when handling glasses, cutlery and dishes. For this reason, thorough cleaning of the dishwasher at regular intervals is indispensable. The patented AUTO-CLEAN self-cleaning system takes care of this time-consuming step on behalf of you.

### YOUR BENEFIT:

The sophisticated arrangement of the dedicated cleaning nozzles ensures automatic cleaning of the machine interior and the heat recovery system.

## MOULDED DRAIN ELEMENT

Soil is directed via beads to a central point and into the drain. This prevents soil accumulation in the tank.

## COMPLETELY DEEP-DRAWN TANK

Prevents soil accumulation

**Soil does not stand a chance to accumulate:** the design of tank sump and tank bottom does not offer soil any chance of depositing.

### FOR YOU THIS MEANS:

Ideal conditions make for easy cleaning and lastingly sound hygiene conditions.

## CONDENSER

Easy to clean

### One single action is all it takes:

Simply removing the front cover provides ideal access for hosing down the condenser.



# DRAWINGS / MODULE SELECTION

## PRE-WASH ZONES

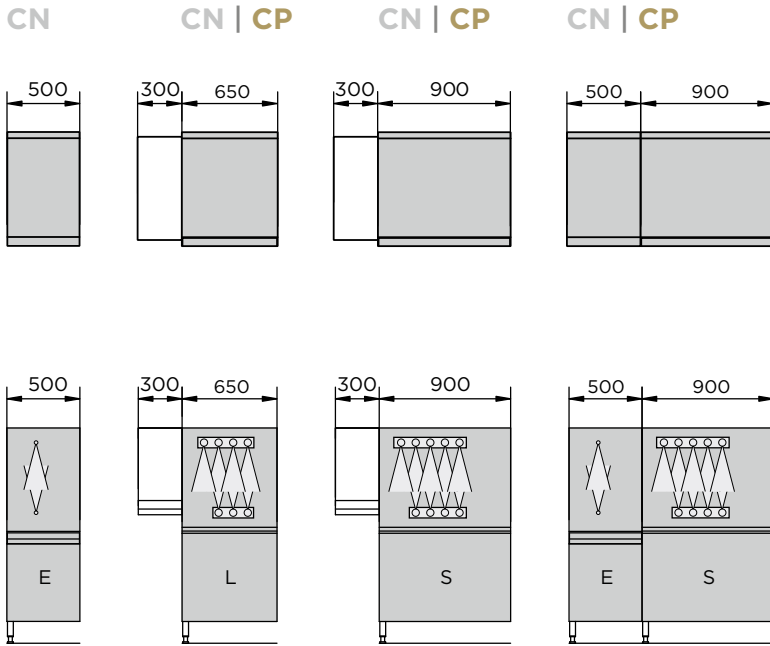

## CN

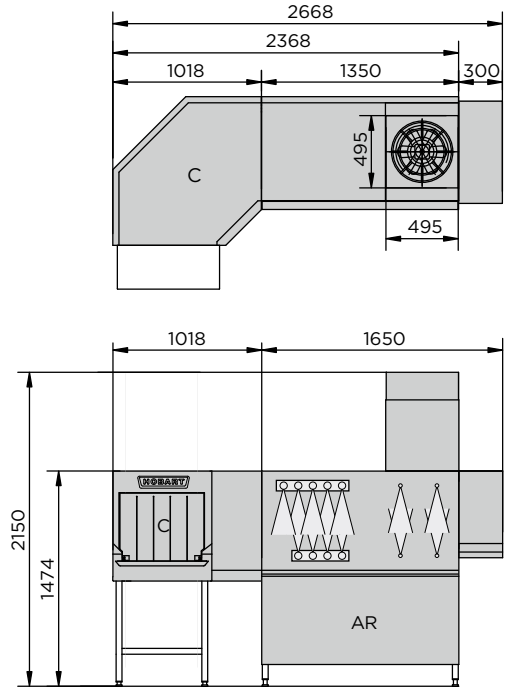

## MAIN WASH ZONE / RINSE ZONE

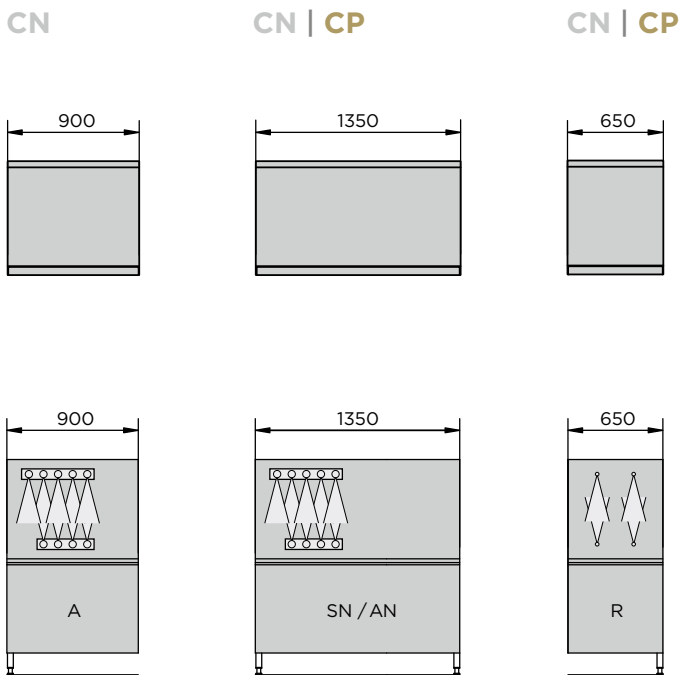

## CN

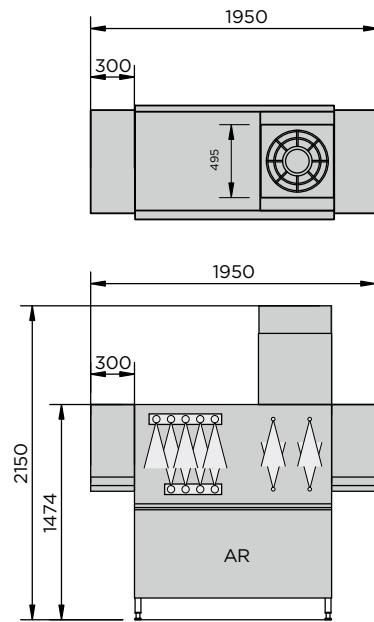

**DRYING ZONE**

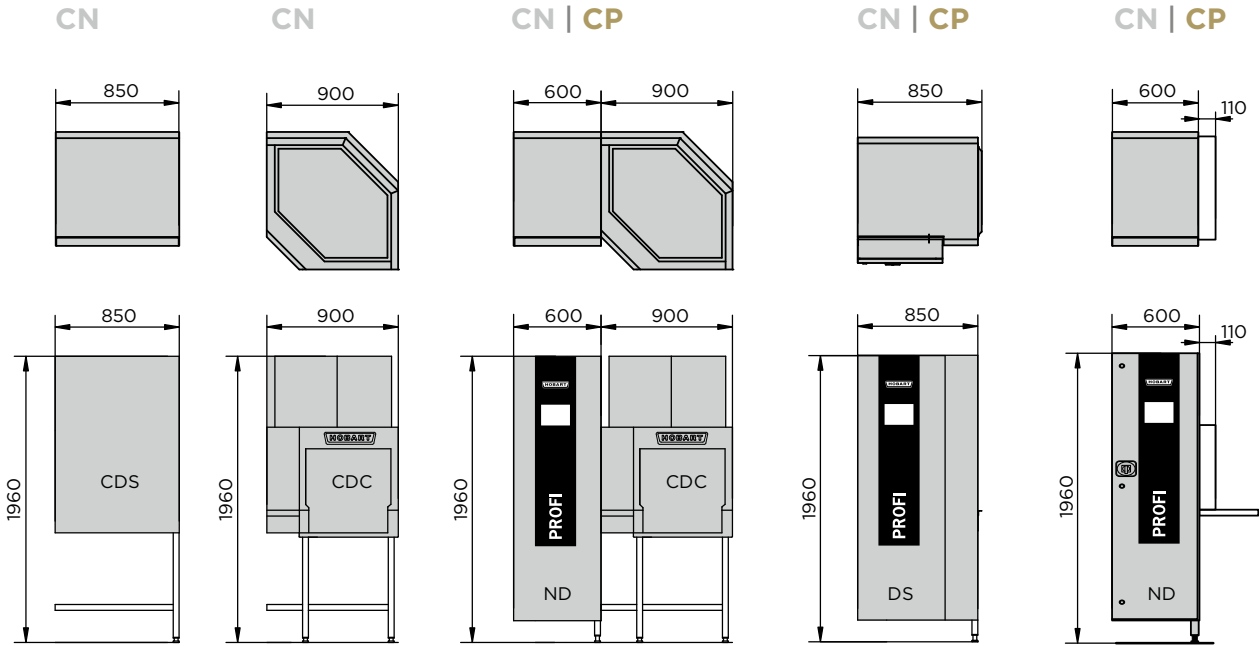

**HEAT RECOVERY / HEAT PUMP**

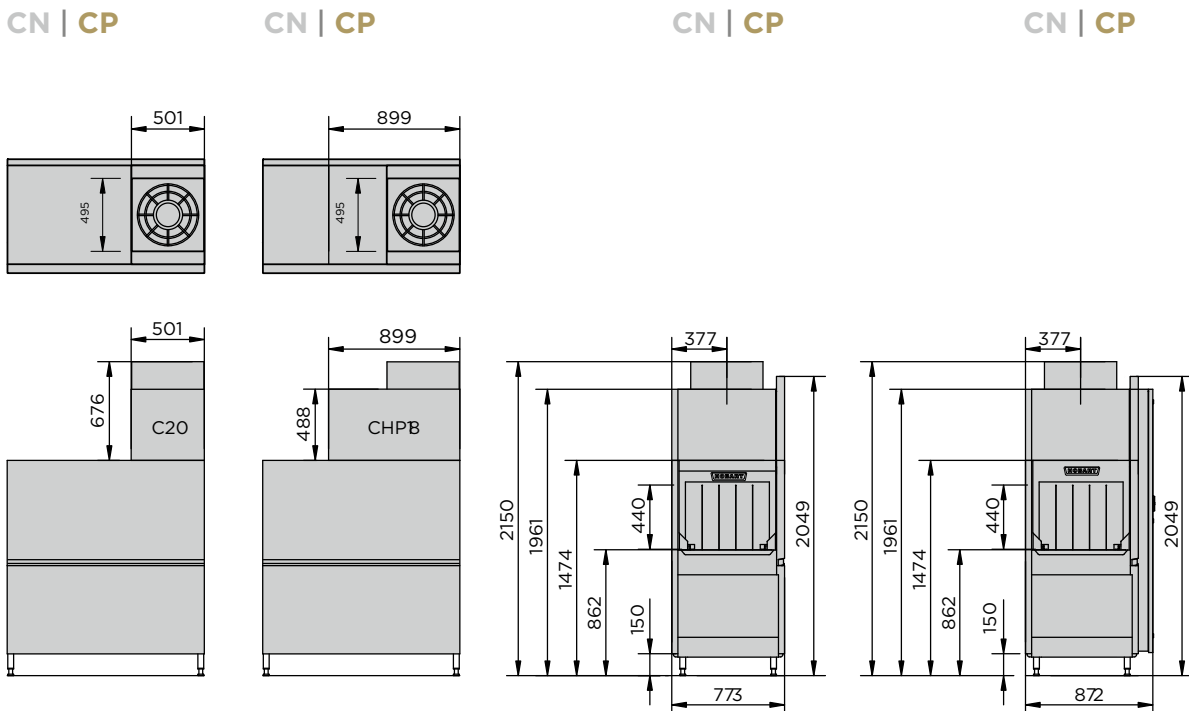

## FEATURES

MODEL	PROFI CN	PREMAX CP
<b>HIGH LEVEL OF ECONOMY</b>		
50PERCENT fresh water rinse	-	● <b>PREMAX LINE EXCLUSIVE</b>
TOP-TEMP energy management	-	● <b>PREMAX LINE EXCLUSIVE</b>
CLIMATE energy saving system	○	●
CLIMATE-PRO energy saving system	○	○
Efficiency concept	●	●
LOW-CHEM detergent saving system	●	●
<b>BEST WASH AND DRYING RESULT</b>		
HOT-TEMP washing	-	● <b>PREMAX LINE EXCLUSIVE</b>
TRI-RINSE	●	●
CONTACT-PLUS wash system	●	●
RO-L reverse osmosis system	○	○
DYNAMIC-DRY drying	●	●
HIGH-TEMP pumped rinse	-	● <b>PREMAX LINE EXCLUSIVE</b>
<b>SENSOTRONIC WASHING INTELLIGENCE</b>		
AQUA-ADAPT water consumption control	●	●
SENSO-SPACE compartment detection	●	●
BEST-START system check	-	● <b>PREMAX LINE EXCLUSIVE</b>
Wash ware detection	-	● <b>PREMAX LINE EXCLUSIVE</b>
SENSO-ACTIVE resource management	-	● <b>PREMAX LINE EXCLUSIVE</b>
<b>PERMANENT-CLEAN AND RACK-FLOW</b>		
PERMANENT-CLEAN automatic soil removal	○	●
RACK-FLOW sensor system	○	●
<b>EASY HANDLING AND CLEANING</b>		
INFOTRONIC control with USB-interface	●	-
PROTRONIC XL control with USB-interface	○	●
AUTO-CLEAN self-cleaning system	○	●
DROP-IN wash system	●	●
Wash arm slider	●	●
Colour-coded cleaning assistance:	●	●
Colour-coded curtains	●	●
Colour-coded wash and rinse arms	●	●
Moulded drain element	●	●
Completely deep-drawn tank	●	●
Easy cleanable condenser	●	●

● Inklusive

○ Optional

- Not available

## TECHNICAL DATA

PROFI <b>CN</b>									
RACKS in number/h			CONVEYOR SPEED	WATER CONSUMPTION <sup>[1]</sup>		ENERGY CONSUMPTION in kWh <sup>[2]</sup>		RECOMMENDED MODEL SELECTION	TOTAL LENGTH
all speeds: hygienic wash resultbased on DIN 10534			Optional available with 3 speeds for all models			(connected load in kW)			
speed 1	speed 2	speed 3	in m/min	in l/h	in l/rack <sup>[3]</sup>	with CLIMATE energy saving system	with CLIMATE-PRO energy saving system <sup>[4]</sup>		in mm without drying zone
-	80	120	0,67	150	1,3	20,7 (27,6)	15,4 (20,6)	CN-A	1.350
-	100	150	0,83	150	1,0	20,8 (27,8)	15,6 (20,8)	CN-E-A	1.850
-	135	200	1,13	160	0,8	21,8 (29,1)	16,6 (22,1)	CN-L-A	2.000
-	135	200	1,13	160	0,8	21,8 (29,1)	16,6 (22,1)	CN-C-A	2.375
-	150	220	1,25	160	0,7	22,0 (29,4)	16,8 (22,4)	CN-S-A	2.250
120	180	250	1,50	180	0,7	23,4 (31,1)	16,9 (22,6)	CN-E-S-A	2.750
120	190	280	1,58	190	0,7	26,9 (40,2)	22,2 (33,2)	CN-S-A-A	3.150

PREMAX <b>CP</b>									
RACKS in number/h			CONVEYOR SPEED	WATER CONSUMPTION <sup>[1]</sup>		ENERGY CONSUMPTION in kWh <sup>[2]</sup>		RECOMMENDED MODEL SELECTION	TOTAL LENGTH
all speeds: hygienic wash resultbased on DIN 10534						(connected load in kW)			
speed 1	speed 2	speed 3	in m/min	in l/h	in l/rack <sup>[3]</sup>	with CLIMATE energy saving system	with CLIMATE-PRO energy saving system <sup>[4]</sup>		in mm with drying zone
120	180	240	1,50	140	0,6	19,9 (32,1)	15,5 (25,1)	CP-L-A	2.850
120	190	300	1,58	140	0,5	20,0 (32,4)	15,7 (25,4)	CP-S-A	3.100
120	200	320	1,67	140	0,4	19,5 (32,6)	15,9 (25,6)	CP-E-S-A	3.600

<sup>[1]</sup> Fresh-water consumption values under optimised conditions and in **PREMAX** models using the SENSOTRONIC system (different customer-specific values are possible).

<sup>[2]</sup> Average value with an exemplary set of covers and type of business

<sup>[3]</sup> Ideal values

<sup>[4]</sup> Machines with heat pump contain up to 4.7 kg (6.1 t CO<sub>2</sub>-equivalent) of the refrigerant R134a (GWP 1430)



## OUR VISION

Wash without water

Intensive market research has shown, that our customers expect warewashing technology that combines efficiency with optimal performance. We hold ourselves to these claims, and they form the foundation for our vision of „washing without water“. This vision is our continuous incentive to walk on new paths in order to constantly reduce the water, energy and chemical consumption. Step by step, we would like to come closer to our goal with innovative excellence, and we already know.

» Whenever the first machine will be capable of washing without water – it will be a HOBART. «

## THE COMPANY

We are HOBART

HOBART is the world market leader in commercial warewashing technology and renowned manufacturer of cooking, food preparation and waste treatment. Established 1897 in Troy, Ohio, HOBART today employs more than 6,900 employees around the world. At our manufacturing plant in Offenburg, Germany, HOBART develops, produces, and distributes warewashing technology worldwide. All over the world, the hotel and catering trade, cafeterias, bakeries and butcher shops, supermarkets, airlines, cruise ships, automotive suppliers, research centres and pharmaceutical companies swear by our innovative products, which are considered to be economical and ecological market leaders.



## MADE IN GERMANY

We provide this promise of quality to our customers, and it represents our personal standard upheld by all our staff at HOBART.



## OUR FOCUS

Innovative - economical - ecological

This is our philosophy. To us, innovation means continuously setting new standards in technology, combined with real added value for the customer. An enterprise-owned technological centre and an innovation centre for warewashing technology at our headquarters in Germany make this possible. Highly efficient products are created with bundled innovation, which continuously confirm our status as technological leader. To be economical means to set standards in relation to the lowest operating costs and minimal use of resources, and to revolutionise the market continuously. To be ecological means a responsible handling of resources and a sustainable energy policy. This applies not only to the product in use, but in general to all areas of the organisation, such as purchasing or manufacturing.

## HOBART SERVICE

Competent - fast - reliable

HOBART service technicians as well as HOBART service partners are the "real" experts. Thanks to intensive training and many years of experience, these technicians have a unique and profound knowledge of the product. Maintenance and repair work is therefore always carried out professionally, fast, and reliably.

# HOBART

## DEUTSCHLAND/ÖSTERREICH

### HOBART GMBH

Robert-Bosch-Straße 17 | 77656 Offenburg  
Tel.: +49(0)781.600-0 | Fax: +49(0)781.600-23 19  
info@hobart.de | www.hobart.de



Werkskundendienst 0180.345 62 58  
für Österreich 0820.24 05 99

Zentraler Verkauf 0180.300 00 68

## SCHWEIZ

### GEHRIG GROUP AG

Bäulerwisenstrasse 1 | 8152 Glattbrugg  
Tel.: +41(0)43.211 56-56  
Fax: +41(0)43.211 56-99  
info@gehriggroup.ch  
www.gehriggroup.ch

## FRANCE

### COMPAGNIE HOBART

ZI PARIS EST - Allée du 1er Mai - B.P. 68  
77312 MARNE LA VALLEE Cedex 2  
Téléphone: +33(0)1 64 11 60 00  
Fax: +33(0)1 64 11 60 01  
contact@hobart.fr  
www.hobart.fr

## UNITED KINGDOM

### HOBART UK

Southgate Way | Orton Southgate  
Peterborough | PE2 6GN  
Phone: +44(0)844 888 7777  
customer.support@hobartuk.com  
www.hobartuk.com

## BELGIUM

### HOBART FOSTER BELGIUM

Industriestraat 6 | 1910 Kampenhout  
Phone: +32(0)16 60 60 40  
Fax: +32 (0)16 60 59 88  
sales@hobart.be  
www.hobart.be

## NEDERLAND

### HOBART NEDERLAND B.V.

Poppmolenlaan 12 | 3447GK Woerden  
Tel.: +31(0)348.46 26 26  
Fax: +31(0)348-43 01 17  
info@hobart.nl  
www.hobart.nl

## NORGE

### HOBART NORGE

Gamle Drammensvei 120 A | 1363 HØVIK  
Tel.: +47 67 10 98 00  
Fax: +47 67 10 98 01  
post@hobart.no  
www.hobart.no

## SVERIGE

### HOBART SCANDINAVIA APS

Box 2101 | 196 02 Kungsängen  
Tel.: +46 8 584 50 920  
Fax: +46 8 584 50 929  
info@hobart.se  
www.hobart.se

## DANMARK

### HOBART SCANDINAVIA APS

Håndværkerbyen 27 | 2670 Greve  
Tel.: +45 43 90 50 12  
Fax: +45 43 90 50 02  
post@hobart.dk  
www.hobart.dk

## AUSTRALIA

### HOBART FOOD EQUIPMENT

Unit 1 / 2 Picken Street | Silverwater NSW | 2128  
Tel.: +61(0)2 9714 0200  
Fax: +61(0)2 9714 0242  
www.hobartfood.com.au

## KOREA

### HOBART KOREA LLC

7th Floor | Woonsan Bldg | 108 | Bangi-dong  
Songpa-gu | Seoul 138-050  
Phone: +82(0)2 34 43 69 01  
Fax: +82(0)2 34 43 69 05  
contact@hobart.co.kr  
www.hobart.co.kr

## JAPAN

### HOBART (JAPAN) K.K.

Suzunaka Building Omori  
6-16-16 Minami-Oi | Shinagawa-ku | Tokyo 140-0013  
Phone: +81(0)3 5767 8670  
Fax: +81(0)3 5767 8675  
info@hobart.co.jp  
www.hobart.co.jp

## SINGAPORE

### HOBART INTERNATIONAL (S) PTE LTD

158 | Kallang Way | #06-03/05  
Singapore 349245  
Phone: +65(0)6846 7117  
Fax: +65(0)6846 0991  
enquiry@hobart.com.sg  
www.hobart.com.sg

## THAILAND

### HOBART (THAILAND)

889 Thai CC building | 31st Floor | Room no. 311  
South Sathorn Rd. | Yannawa | Sathorn  
Bangkok 10120  
Phone: +66(0)2-675-6279 | Fax: +66(0)2-675-6280  
enquiry@hobartthailand.com | www.hobartthailand.com

## OTHER COUNTRIES

### HOBART GMBH

Robert-Bosch-Straße 17 | 77656 Offenburg | Germany  
Phone: +49(0)781.600-28 20  
Fax: +49(0)781.600-28 19  
info-export@hobart.de  
www.hobart-export.com

Die Angaben in diesem Prospekt beruhen auf dem Stand 09/2017. Technische Änderungen oder Änderungen der Ausführung bleiben vorbehalten.

The details given in this brochure are correct as of 09/2017. We reserve the right to technical or design modifications.

Document non contractuel. Les indications de ce prospectus sont conformes à la mise à jour de 09/2017. Nous nous réservons le droit de modifier les données ou les configurations techniques de nos machines.



MIX  
Papier aus verantwortungsvollen Quellen  
FSC® C084513